

Removal of Power Line Interference and Baseline Wander noise in ECG signal.

Gayatri P. Rathod¹, Rahul D. Ghongade², Rohan R. Fate³

1. M.E. 2nd year, Electronics and telecommunication. P. R. Pote (Patil) college of engineering and management, Amravati.
2. Department of electronics and telecommunication, P. R. Pote (Patil) college of engineering and management, Amravati.
3. Department of electronics and telecommunication, Siddhivinayak Technical Campus, Shegaon.

Submitted: 10-07-2021

Revised: 23-07-2021

Accepted: 26-07-2021

ABSTRACT: ECG signals obtained for diagnosis normally contain a lot of noises and artifacts such as power line interference, baseline wander noise, high frequency noise and noise generated by human body. These noises degrade signal quality, which may be critical for routine monitoring and diagnosis. To solve the problem, a fast Fourier transform/inverse fast Fourier transform (FFT/IFFT) filter for suppressing the power-line interference, baseline wandering is given in this project. De-noising of ECG signal will be done in frequency domain. But as the signal is in frequency domain there can be a aliasing effect, so to avoid this overlapping is removed. And after that filtered ECG signal is reconstructed.

KEYWORDS: Power line interference, Baseline wander noise, FFT/IFFT filter.

I. INTRODUCTION

The main function of the heart is to pump blood throughout the body to bring the oxygen and nutrient demands of the body's tissues as well as to take out carbon dioxide. The project concentrates on two noises that are power line interference and baseline wander noise. It is difficult to work on the signal in time domain. So, the proposed method used in this project is to convert time domain ECG signal into frequency domain signal and then filter out the noises in it using Discrete Fourier transform. FFT is a Fast Fourier transform technique used for Discrete Fourier transform. So, basically reason behind using FFT/IFFT filter is to get reduced power line interference as well as baseline wander noise. As, the frequency of both these noise is unlike the filter have to work on two different cut-off frequencies. So, this filter can also be called as reconfigurable filter.

[1]. a reconfigurable overlapping FFT/IFFT filter for de-noising of ECG signals on the nodes is

used. This filter can suppress power-line interference and high frequency artifacts. Compared to conventional approaches, the processing of the ECG signal on the nodes is much more suitable and proficient. The input ECG signal is obtained from the patient directly and for obtaining it a 12 lead holter is designed. This holter contains the analog to digital convertor, microprocessor and the FPGA. Two filters: a comb filter to suppress power-line interference and a band-pass filter to suppress the baseline wandering and the high-frequency noise is used. In this paper, a reconfigurable filter is used that can be configured to work as a comb filter or as a band-pass filter. The cut-off frequency is configured by adjusting the pass-band of the filter. This functionality is easy to execute in FPGA. FFT/IFFT filter is reconfigurable and simple to implement.

[2] A technique for obtaining an appropriate signal model by using preliminary wavelet shrinkage with time-frequency dependent threshold (TFDT). This recently proposed threshold is related to ECG signal morphology and has shown its out-performance in comparison with other thresholds in ECG denoising. The literature also improves the WDWF capabilities applying it in translation-invariant wavelet domain - TIWDWF. It gives a new two-stage algorithm for electrocardiographic (ECG) signal de-noising has been proposed. It combines wavelet Shrinkage with Wiener filtering in translation-invariant wavelet domain. The de-noising approach is to decompose the signal noise mixture in transform domain, where a small number of significant Coefficients signifies the signal features while the rest big number of small value coefficient are inconsequential. As the noise is spread over all transform coefficients the small ones are harder subjective by it. Disregarding the coefficients below a determined threshold one

can get noise-free signal estimation by inverse transform. Wiener filtering gives improved results while using both an adequate signal estimate.

[3]. An adaptive LMS and normalized least mean square (NLMS) filter is used to remove noise from the ECG signal. NLMS filter removes all specified noise more significantly than LMS. The original ECG signal is taken from the MIT-BIH arrhythmia database. The different types of noise signal are generated by using MATLAB®. The noise signal is then added with the real ECG signal. To remove the different types of noises, the noisy ECG signal is then passed through two adaptive filter algorithms (e.g., LMS and NLMS). The different performance parameters SNR, %PRD, MSE and also visual parameters PSD, frequency spectrum and convergence reveals that adaptive NLMS filter is more considerable for removing different types of noises from ECG signal.

[4]. A Block LMS algorithm is used, in which the coefficient vector is updated only once every occurrence based on a block gradient estimation. The BLMS algorithm is given for random reference inputs. When the input is stationary, the same steady state misadjustment and convergence speed as the LMS algorithm. An advantage of the block, or the transform domain, LMS algorithm is that the input signals are approximately uncorrelated. Moreover, the filter output and the weight update terms can be evaluated faster using FFT-based fast BLMS (FBLMS) algorithm. The advantage of this algorithm is less computational complexity and good filtering capability. These characteristics play a very important role in biotelemetry, where extraction of clean ECG signal for efficient diagnosis and fast computations, high data transfer rate are desired to avoid overlapping of pulses and to decide ambiguities. A FBLMS algorithm is used to remove the artifacts from ECG. Such a realization is intrinsically less complex than its BLMS based counterpart. This algorithm gives less computational complexity and good filtering capability. The performance of this algorithm is studied to effectively remove the noise from the ECG signal, simulations are carried out on MIT-BIH database for different artifacts. This performs better than the LMS counterpart to eliminate the noise from ECG.

[5]. A method for ECG de-noising based on Wavelet Shrinkage approach using Time-Frequency Dependent Threshold (TFDT) has been used. The TFDT is elevated for the non-informative wavelet coefficients, and low down for the informative coefficients representing the significant signal features. In this literature the de-noising is enhanced by involving Empirical Wiener Filtering

in Wavelet Domain using the TFDT for calculation of the “pilot” signal estimation. Here two-stage algorithm is used for achieving the de-noising. In this technique decomposing of the basic functions is especially significant and this can be improved by the transform domain coefficients. Empirical Wiener Filtering in Wavelet Domain using the TFDT for calculation of the “pilot signal estimation” is used. By experiments on a wide range database, they have qualified the applicability of the Empirical Wiener filtering in wavelet domain for the particular case of ECG denoising.

II. ECG ANALYSIS

The ECG signals analyzed and processed during this paper work are taken from Massachusetts Institute of Technology-Beth Israel Hospital (MIT-BIH) database. The MIT-BIH Arrhythmia Database was the first generally available set of standard test material for valuation of arrhythmia detectors, and it has been used for that purpose as well as for basic research into cardiac dynamics.

To plot ECG signal from database in MATLAB version 7 first step is to download the ECG signal from MIT-BIH database in .mat format for MATLAB and .info file for information purpose. Save both file in one folder. This database is freely available at phisionet.org website. Open .info file in notepad. It will give you information like duration of signal, sampling frequency, sampling interval. The signal is given in the raw unit form. For conversion from raw unit to physical unit (mV), subtract base and divide by gain. Then go to the MATLAB and choose directory where ECG signal is stored. As soon as you click on it you can see the .mat file and .info file in current folder. Then take a new script and write a code to load the signal in MATLAB. You need to write the information given in .info file in code i.e. sampling frequency, interval, and for conversion in physical unit base and gain is used. After this procedure you can plot the ECG signal.

The ECG signal taken from database is pure signal without any noise in it. In this project we are working on two noises viz. power line interference and baseline wander noise. So, we need to generate these signals and add it in our original ECG signal. The frequency of power line interference is 50 Hz and baseline wander is 0.05 Hz. So, a code is written for generation of these two noises. The noise signal is added in original ECG signal and processed further.

III. PROPOSED METHOD

In this paper we are focusing on removal of two noises that are; Power line interference and Baseline wander noise. Both of these noises have different frequencies. As discussed in previous point the frequency of power line interference is 50Hz and baseline wander noise is 0.05Hz [1]. These noises will be filtered out after converting time domain signal in frequency domain. ECG signal is converted by using Fast Fourier Transform. The block diagram for the proposed method is shown in Figure 1.

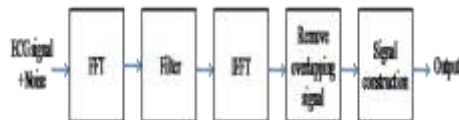

Figure 1: Block diagram of proposed method

As shown in above block diagram the ECG signal from MIT-BIH database is downloaded and then added with noise in MATLAB and applied as an input. Then for converting the signal in frequency domain it is applied to the FFT block. Signal is converted to frequency domain by taking Discrete Fourier Transform. After converting signal in frequency domain is applied to filter to filter out the noise i.e. the power line interference and the baseline wandering in the ECG signal. The filter should be able to remove the noise in ECG signal. So, filter has to work on the different cut-off frequencies as the frequency of power line interference and baseline wander noise is different. This filter can be called as reconfigurable filter as it will work for different cut-off frequency. After removal of the noise from the signal we have to again convert the signal in time domain and for that reason it is applied to the IFFT block. This block will perform Inverse Fast Fourier transform on the filtered signal and convert it back to time domain. As, for diagnosis the signal should be in time domain not in frequency spectrum. But when the PLI is removed from the ECG signal some of the ECG signal also gets cancelled as the frequency of power line interference as well as the ECG signal is 50Hz. To avoid this mechanism is used to remove the overlapping of the signal which will give the ECG signal without overlapping. All these operations given above are performed on the samples of ECG signal at the final stage the signal is reconstructed i.e. assembled. This total filter can be called as reconfigurable overlapping FFT/IFFT filter.

After taking ECG signal from database it is divided into smaller parts. We have selected the size of 512 samples for each small part of the ECG signal. For the processing purpose we are selecting ECG signal

of length 21 seconds with FS 360Hz. So for 21 seconds the total samples are 7560. So while processing it we have to make only 16 parts of the selected 21 sec signal. If we take more than 16 parts then the code will not work and if we select less than 15 then more no of samples will have to discard after processing.

Power line interference with 50 Hz frequency and 0.3 mV of amplitude is added in ECG signal. This noise is generated in MATLAB. The second noise is baseline wander noise which has frequency of 0.05 Hz. This noise is also generated in MATLAB.

The ECG signal we are working on is in time domain. But in this project we are working on the signal in frequency domain. So the ECG signal is first added with noise and then converted in frequency domain. The signal is converted from time domain to frequency domain using Fast Fourier Transform in MATLAB using FFT command with N=512. FFT(X) is the discrete Fourier transform (DFT) of vector X. For matrices, the FFT operation is applied to each column. For N-D arrays, the FFT operation operates on the first non-singleton dimension. FFT(X,N) is the N-point FFT, padded with zeros if X has less than N points and truncated if it has more. N-point FFT is performed for each series, including the overlapping parts. The functions Y=fft(x) and Y=ifft(X) implement the transform and inverse transform pair given for vectors of length by:

$$X(k) = \sum_{j=1}^N x(j)\omega_N^{(j-1)(k-1)}$$

$$x(j) = (1/N) \sum_{k=1}^N X(k)\omega_N^{-(j-1)(k-1)}$$

where

$$\omega_N = e^{(-2\pi i)/N}$$

is an Nth root of unity. Y = fft(X,n) returns the n-point DFT. If the length of X is less than n, X is padded with trailing zeros to length n. If the length of X is greater than n, the sequence X is truncated. When X is a matrix, the length of the columns is adjusted in the same manner.

To filter out power line interference a notch filter is designed in MATLAB. The power line interference has frequency of 50 Hz. So a notch filter is designed to remove this 50 Hz notch. Notch filters aim to remove one or a few frequencies from a broader spectrum. You must specify the frequencies to remove by setting the filter design options in FDATool appropriately:

- Response Type
- Design Method

- Frequency Specifications
- Magnitude Specifications

By setting all these parameters in FDAtool a notch filter can be designed. Here in this project we are using a command `iirnotch` to design a notch filter. `[num,den] = iirnotch(w0,bw)` turns a digital notching filter with the notch located at w_0 , and with the bandwidth at the -3 dB point set to bw . To design the filter, w_0 must meet the condition $0.0 < w_0 < 1.0$, where 1.0 corresponds to π radians per sample in the frequency range.

The quality factor (Q factor) q for the filter is related to the filter bandwidth by $q = w_0/bw$ where ω_0 is w_0 , the frequency to remove from the signal.

`[num,den] = iirnotch(w0,bw,ab)` returns a digital notching filter whose bandwidth, bw , is specified at a level of $-ab$ decibels. Including the optional input argument ab lets you specify the magnitude response bandwidth at a level that is not the default -3 dB point, such as -6 dB or 0 dB.

The other noise is baseline wander noise with frequency 0.05 Hz. By addition of this noise the ECG signal will be drifted. To filter out this drift a low pass filter is designed. It will filter out the baseline wander noise. This low pass filter is designed in FDAtool.

After filtering out the noises in ECG signal it is again converted in time domain because we cannot analyze it in frequency domain. To convert the filtered ECG signal back in time domain Inverse Fast Fourier Transform is used. There is IFFT command in MATLAB to take Inverse Fast Fourier Transform. `IFFT(X, N)` is the N-point inverse transform of X . `y = ifft(X)` returns the inverse discrete Fourier transform (DFT) of vector X , computed with a fast Fourier transform (FFT) algorithm. If X is a matrix, `ifft` returns the inverse DFT of each column of the matrix. `ifft` tests X to see whether vectors in X along the active dimension are conjugate symmetric. If so, the computation is faster and the output is real. An N-element vector x is conjugate symmetric if $x(i) = \text{conj}(x(\text{mod}(N-i+1,N)+1))$ for each element of x .

Before adding noise to ECG signal it is divided into smaller parts. The hypothesis of Fourier transform is that the signal is periodic. Using Fourier transform, a periodic signal can be decomposed into a sum of a set of simple periodic functions sines and cosines. However, an ECG signal mixed with noises is not a perfect periodic signal, i.e. the values of the first and the last samples in the N-point data block are not the same. This means that neither the function of the input analog signal nor its first derivative is continuous. This results in an aberration in the beginning and at the end of the IFFT series. The method to solve the

problem is to increase the length of the block. To increase the length of the series allows analyzing of more frequency components of the signal and reduces the spectral leakage.

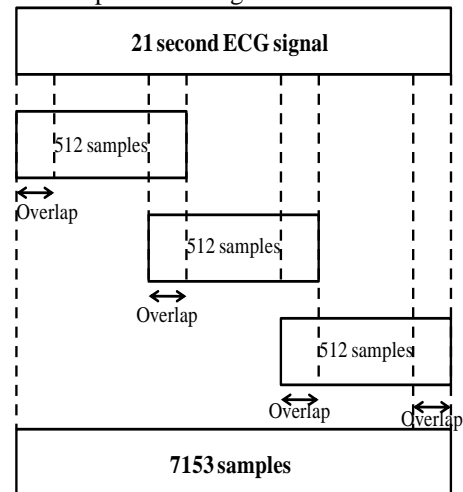

Figure 2: Removing overlapping in signal

The role of the overlapping parts is to decrease the frequency aliasing that resulted from the lack of periodicity in the block data and the non-periodic signal in the FFT. Since the overlapping parts that contain large frequency aliasing are abandoned, the outcome is satisfying. After the frequency conversion in the frequency domain, N-point IFFT is performed to convert the signal from the frequency domain to the time domain. Then, overlapping parts of the signal in the time domain are abandoned, and the blocks formed from the remaining signals are used to construct the output signal of the filter. After removing overlapping from the samples the ECG signal is reconstructed which is the final output of our system.

IV. RESULTS

In this part result of our work i.e. filtered ECG signal is given. Here we will see removal of power line interference and baseline wander noise in results generated in MATLAB.

Correlation Coefficient is the measure of how much the signal is correlated with other signal. The correlation coefficient gives the measure of similarity between the original ECG signal and the de-noised ECG signal. This technique is more use full for performance evaluation if the working is takes place on the simulated data. So that it will give the results that how much of the signal is actually extracted from the contaminated signal. The correlation coefficient is calculated using the MATLAB 'corrcoef' function.

Correlation coefficient for PLI is 0.92 and for BW is 0.80.

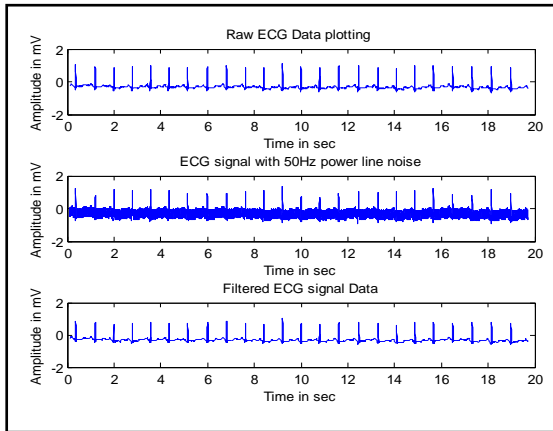

Figure 3: removal of PLI from ECG signal

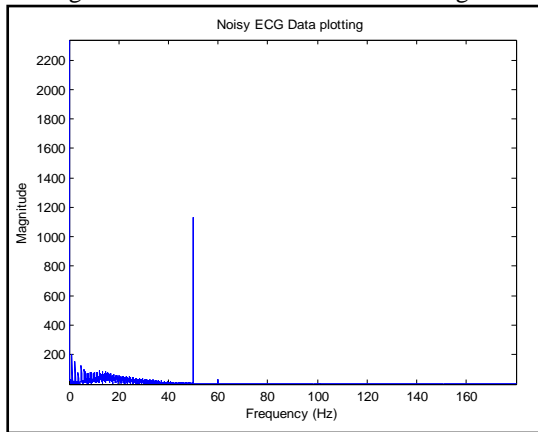

Figure 4 Frequency response of ECG with PLI

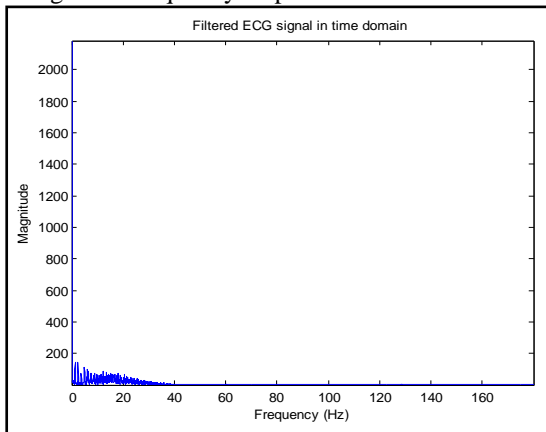

Figure 5 Frequency response of filtered ECG

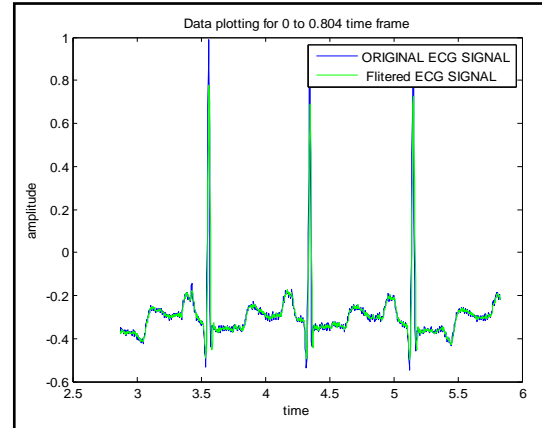

Figure 6: Comparison of original signal and filtered signal

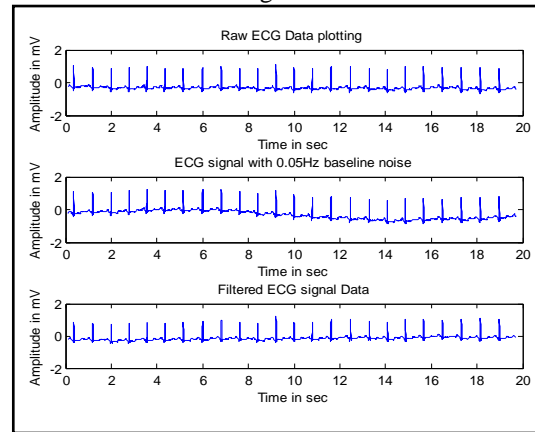

Figure 7: Removal of Baseline wandering from ECG signal

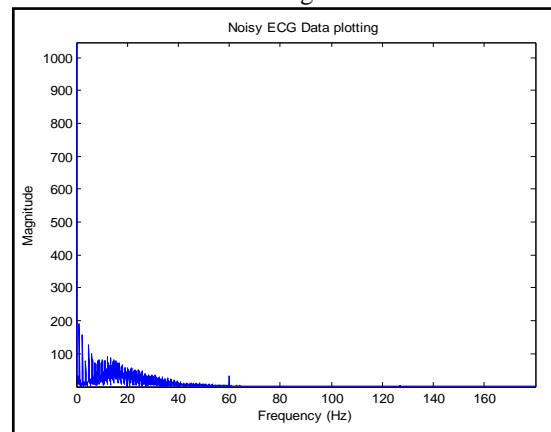

Figure 8: Frequency response of ECG with Baseline wandering

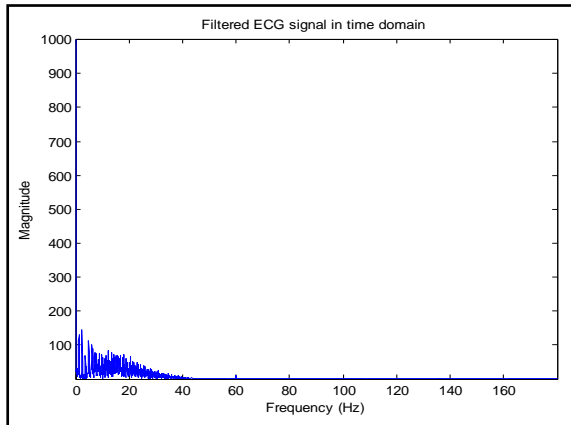

Figure 9: Frequency response of filtered ECG

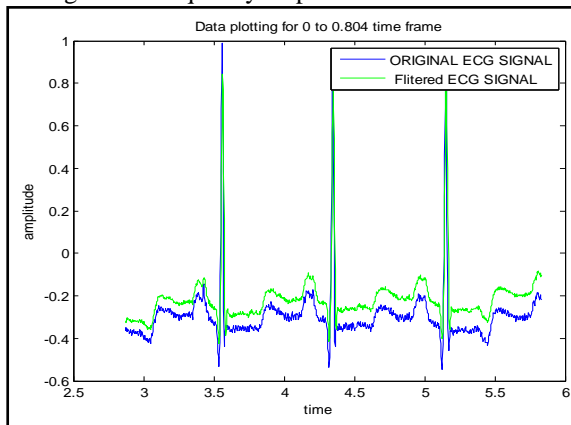

Figure 10: Comparison of original ECG and filtered ECG

V. CONCLUSION

In this paper we designed a FFT/IFFT filter to remove the power line interference and the baseline wander noise in the ECG signal. This is achieved by converting a sampled ECG signal in time domain to frequency domain by using FFT and then the signal in frequency domain is filtered by designing a notch filter for power line interference and low pass filter for baseline wander noise in MATLAB. After that to avoid aliasing effect overlapping is removed from samples and again the signal is converted from frequency domain to time domain using IFFT.

REFERENCES

- [1]. A Reconfigurable Overlapping FFT/IFFT Filter for ECG Signal De-noising by Nannan Zhang, Zedong Nie, Yu Luo, Leilei Du, Xiaohui Wang, and Lei Wang. IEEE International Symposium on Bioelectronics and Bioinformatics (IEEE ISBB 2014)
- [2]. WAVELET DOMAIN WIENER FILTERING FOR ECG DENOISING USING IMPROVED SIGNAL ESTIMATE. Nikolaev, Z. Nikolov, A. Gotchev, K. Egiazarian. 0-7 803-6293-4/00/\$10.0002000 IEEE
- [3]. ECG signal de-noising by using Least Mean Square and Normalized Least Mean Square algorithm based adaptive filter by Uzzal Biswas, Anup Das, Saurov Debnath and Isabela Oishee. 3rd International conference on Informatics, Electronics and vision 2014.
- [4]. Denoising ECG Signals using Transform Domain Adaptive Filtering Technique by Mohammad Zia Ur Rahman, Rafi Ahamed Shaik, D V Rama Koti Reddy. India conference (INDICON), 2009 annual IEEE, E-ISBN 978-1-4244-4859-3.
- [5]. ECG SIGNAL DENOISING USING WAVELET DOMAIN WIENER FILTERING. Nikolay Nikolaev and Atanas Gotchev, 2000 IEEE International conference on volume-6, E-ISBN 1520-6149.
- [6]. Comparisons of Different Approaches for Removal of Baseline Wander from ECG Signal. by Manpreet Kaur, Birmohan Singh, Seema, 2nd International Conference and workshop on Emerging Trends in Technology (ICWET) 2011.
- [7]. ECG baseline wander removal and noise suppression analysis in an embedded platform by Victor Barbero Romero, 2008-2009.
- [8]. REDUCTION OF POWER LINE INTERFERENCE IN ECG SIGNAL USING FIR FILTER by Ms. Geeta Kadam, Prof.P.C.Bhaskar /International Journal of Computational Engineering Research/ ISSN: 2250-3005
- [9]. Enhancement of ECG signal by DFT using Fast Fourier Transform (FFT) Algorithm by Jitendra Kumar Verma, Anil Kumar and Arvind Kumar Jaiswal, International Journal of Current Engineering and Technology E-ISSN 2277 – 4106, P-ISSN 2347 – 5161.
- [10]. Removal of power-line interference from the ECG: a review of the subtraction procedure Chavdar Levkov, Georgy Mihov, Ratcho Ivanov, Ivan Daskalov, Ivaylo Christov and Ivan Dotsinsky. BioMedical Engineering OnLine 2005.
- [11]. Review Paper Various Techniques for Removal of Power Line Interference From ECG Signal by Snehal Thalkar, Prof. Dhananjay Upasani. International Journal of Scientific & Engineering Research, Volume 4, Issue 12, December-2013 ISSN 2229-5518

- [12]. An efficient removal of power-line interference and baseline wander from ECG signals by employing Fourier decomposition technique by Amit Singhala, Pushpendra Singh, Binish Fatimah, Ram Bilas Pachori. Biomedical Signal Processing and Control 57 (2020) 101741.
- [13]. Baseline Wander and Power-Line Interference Removal from ECG Signals Using Fourier Decomposition Method by Pushpendra Singh, Ishita Srivastava, Amit Singhal and Anubha Gupta. Springer Nature Singapore Pte Ltd. 2019 M. Tanveer and R. B. Pachori (eds.), Machine Intelligence and Signal Analysis, Advances in Intelligent Systems and Computing 748, https://doi.org/10.1007/978-981-13-0923-6_3
- [14]. A NEW METHOD FOR REMOVAL OF BASELINE WANDER AND POWER LINE INTERFERENCE IN ECG SIGNALS by ZHI-DONG ZHAO , YU-QUAN CHEN, Proceedings of the Fifth International Conference on Machine Learning and Cybernetics, Dalian, 13-16 August 2006
- [15]. Reconfigurable filtering using FFT/IFFT for PLI and High frequency artifacts removal in Real Time ECG Signal by Prajna K B, Padmavathi C in International Journal of Scientific & Engineering Research, Volume 6, Issue 9, September-2015 ISSN 2229-5518.
- [16]. Analysis of ECG De-noising by Dipak Kumar Ghosh, LAP LAMBERT Academic publication.