

# Modeling of Graphene Based Enzyme Field Effect Transistor with Ppy/K/CNT as Sensing Layer for Cholesterol Detection

Rupjyoti Kalita

Junior Engineer, Telecom Department, Power Grid Corporation of India Limited, Guwahati., India

Submitted: 01-10-2021

Revised: 10-10-2021

Accepted: 12-10-2021

**ABSTRACT:** A physical model for graphene based enzyme field effect transistor (G-ENFET) for cholesterol detection has been developed. The device replaces silicon substrate with p-type graphene substrate and uses heavily doped n-type graphene for source and drain regions.  $ZrO_2$  having high dielectric constant is used as gate insulator and the sensing membrane for the substrate (cholesterol) on which the enzyme cholesterol oxidase (ChOx) is immobilized is made up of a composite of potassium doped carbon nanotube with polypyrrole (PPy/K/CNT). The modeling of the device has been done by considering various potentials in the device from which a set of equations are derived that characterize the electrolyte enzyme insulator semiconductor (EEIS) structure. The output is measured in terms of drain current variations at different cholesterol concentrations. A comparison between the experimental results of the fabricated device with the modeling results gives a good fit.

**Keywords:** Carbon nanotube, Cholesterol, Graphene, Sensor Phenomena and Modeling

## I. INTRODUCTION

Cholesterol level in the body is an important indicator of diseases like myocardial infarction, hypertension, arteriosclerosis and dysfunctions in lipid metabolism [1]. Therefore, detecting cholesterol levels in the body accurately is important for medical science.

At nano level, graphene based BioFETs have lot of advantages such as high electrical conductivity, small size, better power dissipation, high reliability, less leakage and immune to short channel effects [2]. Not only graphene is biocompatible but also it has good compatibility with high  $\kappa$  dielectrics, which further leads to device miniaturization and improved device performance. Due to these reasons, graphene based biosensors will have importance in nano-biosensing area, specially at "point-of-care" testing locations without

laboratory support. This paper, therefore reports the modeling of a graphene based enzyme field effect transistor with PPy/K/CNT as sensing layer for cholesterol detection. The details of fabrication and characterization of the device can be obtained in one of our earlier papers [3] [4].

The drain current equation of the FET device gives the transduction effect from chemical to electrical domain. In this work, an equation for electrolyte-insulator potential is derived from the various equations of the physico-chemical model [5], [6], which is further related to pH of the solution using Bousse's model [7]. The changes in pH gives the changes in threshold voltage, which acts as the input for the device. Then, the changes in drain current with change in substrate concentration is observed. The modeling results show good agreement with the experimental results.

## II. EEIS STRUCTURE DEVELOPMENT

The EEIS structure is a development of the Electrolyte-Insulator-Semiconductor (EIS) structure [5] of an ISFET with an extra sensing membrane layer added. The sensing membrane layer is assumed to be very close to the oxide layer. The development of the EEIS structure for this device is done from a basic n-channel bioFET structure [5] with the following assumptions:

- The sensing membrane is very close to oxide layer.
- The effect of Helmholtz capacitance and charge density exists only in upper side of the sensing membrane.

Following the site-binding theory [8], the binding occurs on the surface of the oxide layer, giving rise to a locus of centers of adsorbed ions, which forms pairs with charged surface sites. This process is known as surface complexation. Hence, even if the sensing membrane is very close to the oxide layer, IHP (Inner Helmholtz Plane) and OHP (Outer Helmholtz Plane) are formed above the oxide layer.

So, the OHP1 is assumed to be in between the sensing and oxide layer. Another OHP2 is formed above the sensing layer. IHP2 is not formed above the sensing membrane as no surface complexation occurs there. Fig. 1 shows the complete description of the EEIS model of the device showing potential

drops at various levels of the device. Changes in substrate concentration at the surface of oxide layer results in potential variation, which further leads to change in device current. In this way, the levels of substrate biomolecules can be detected.

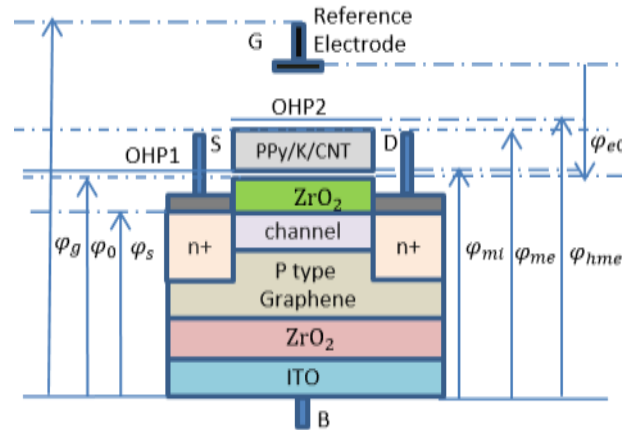
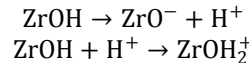
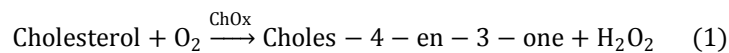

Fig. 1. Complete EEIS model of the device.

Protonation and deprotonation reactions of zirconium oxide can be given as:



For detection of cholesterol, the enzyme ChOx is used. The chemical reactions (1) and (2) shows the breakdown of cholesterol under the influence of the enzyme cholesterol oxidase which leads to production of  $\text{H}^+$  ions.



The interactions results in twice the concentration of hydrogen ions in the bulk. Time dependent diffusion of hydrogen ions from bulk to the surface of oxide layer is considered using Fick's second law.

The equations for the device are modified from the equations of n-channel bioFET structure [4], which are as given below:

The expression for  $\varphi_g$  is given by:

$$\varphi_g = \varphi_{hme} + \frac{2kT}{q} \sinh^{-1} \left\{ \frac{C_h(\varphi_{hme} - \varphi_{me})}{\sqrt{8\epsilon_w kTC_0}} \right\} \quad (3)$$

where  $k$  is the Boltzmann constant,  $T$  is the temperature,  $\epsilon_w$  is the permeability of water,  $C_h$  is the helmholtz capacitance,  $\varphi_{hme}$  is the potential at OHP of upper side of the sensing membrane,  $\varphi_{me}$  is the potential at IHP of the sensing membrane and  $C_0$  is the ion concentration of electrolyte.

By applying Gauss law, to the structure and assuming only one side of the membrane has Helmholtz capacitance effect, we get the expression for  $\varphi_0$  as in equation (4).

$$\varphi_0 = \varphi_{mi} - \sigma_m \left( \frac{1}{C_h} + \frac{1}{C_i} \right) + (\varphi_{hme} - \varphi_{me}) \left( 2 + \frac{C_h}{C_i} \right) \quad (4)$$

$$\frac{1}{C_h} = \frac{1}{C_{IHP}} + \frac{1}{C_{OHP}}$$

Where,

$$C_{IHP} = \frac{\epsilon_{IHP}}{d_{IHP}} \quad C_{OHP} = \frac{\epsilon_{OHP}}{d_{OHP}}$$

And ,

$$\sigma_m = C_m (\varphi_{mi} - \varphi_{me})$$

where  $\sigma_m$  is the charge density in the membrane and  $C_i$  is the capacitance between sensing and oxide layer. Since, both the layers are very close to each other the value of  $C_i$  is larger than  $C_h$ .

The  $\varphi_{me}$  in the above equations is given by:

$$\varphi_{me} = \frac{C_i(C_m + C_h)}{3C_iC_m + C_iC_h + C_iC_h} \left[ \left\{ \varphi_0 + \sigma_m \left( \frac{1}{C_h} + \frac{1}{C_i} \right) + \varphi_{hme} \left( 2 + \frac{C_h}{C_i} \right) \right\} \left( \frac{C_m}{C_m + C_h} \right) + \frac{\sigma_m}{C_m + C_h} + \frac{C_h}{C_m + C_h} \varphi_{hme} \right] \quad (5)$$

From Fig. 1, it can be observed that the electrolyte insulator potential,  $\varphi_{eo}$  is the difference between the gate potential and oxide potential and its expression is given by equation (6).

$$\varphi_{eo} = \varphi_g - \varphi_o \quad (6)$$

Again, the threshold voltage of the device is dependent on the electrolyte insulator potential (assuming other factors almost constant) and is given by equation (7).

$$V_{th,G-ENFET} = E_{ref} - (\varphi_{eo} - \chi_{sol}) - \left[ \frac{Q_{ss} + Q_{sc}}{C_{ox}} - 2\Phi_F + \frac{\Phi_{grap}}{q} \right] \quad (7)$$

where  $E_{ref}$  is the reference potential of electrode,  $\Phi_F$  is the fermi potential of graphene,  $\chi_{sol}$  is the dipole potential of biomolecules,  $C_{ox}$  is the oxide capacitance,  $Q_{ss}$  is the insulator semiconductor interface charge,  $Q_{sc}$  is the semiconductor surface depletion region charge and  $\Phi_{grap}$  is the work function of graphene.

From the Bousse's model the pH of the solution is modified as follows:

$$pH = pH_{pzc} - (\varphi_{eo}) \left[ \frac{q}{2.303 kT} \frac{\beta + 1}{\beta} \right] \quad (8)$$

where  $pH_{pzc}$  is the pH at point of zero charge and  $\beta$  is a parameter dependent on total number of sites.

The effect of hydrogen ion concentration on pH is studied by the Fick's Second Law. The bulk hydrogen concentration is twice the concentration of cholesterol. Therefore, the surface hydrogen ion concentration can be modeled by a time dependent equation given by the Fick's second law:

$$[H^+]_s = [H^+]_b \sqrt{t} \exp\left(\frac{-x^2}{4Dt}\right) \quad (9)$$

where  $[H^+]_s$  is the concentration of hydrogen ions at the surface, and  $[H^+]_b$  is the concentration of hydrogen ions in the bulk,  $t$  is the time taken by the biomolecules to diffuse from bulk to surface,  $x$  is the diffusion length and  $D$  is the diffusion constant given by:

$$D = \frac{1}{2t} x^2 \quad (10)$$

The drain current equation of the device is same as the drain current equation of MOSFET with its threshold voltage modified for the G-ENFET device as given in equation (11) and (12).

$$I_{ds,non-sat} = \beta (V_{gs} - V_{th,G-ENFET}) V_{ds} - \frac{1}{2} V_{ds}^2 \quad (11)$$

$$I_{ds,sat} = \frac{1}{2} \beta (V_{gs} - V_{th,G-ENFET})^2 \quad (12)$$

### III. RESULTS AND DISCUSSIONS

The simulation of the model was done using MATLAB tool. Most of the parameters for simulation were taken from the fabricated device. The most influential parameter values used in modeling are tabulated in Table 1.

Table 1 Parameter symbols and values

Parameter	Symbol	Value
Dielectric constant of water	$\epsilon_w$	80
Drain Voltage	$V_{ds}$	0 to 0.4 volts [3]
Helmholtz capacitance	$C_h$	Varies with $d_{IHP}$ and $d_{OHP}$
Membrane charge density	$\sigma_m$	$2.4 \times 10^{-6}$
Dipole potential of biomolecule	$\chi_{sol}$	0.2
Oxide Thickness	$t_{ox}$	10 nm [3]

Using the parameter values, the value of  $\phi_{eo}$  is calculated at different cholesterol concentration using equation (6). This difference between gate and oxide potential is the major parameter for change in current. The corresponding change is pH with  $\phi_{eo}$  is found out using the Bousse's model as shown in equation (8). The plot in fig. (2), depicts the relationship between surface potential and pH. As the pH of the substrate is increased, there is a decrease in the surface potential.

It is seen that the surface potential varies because of the changes in hydrogen ions at the surface of the device, which behaves as ion sensitive field effect transistor (ISFET). From the analysis of diffusion of hydrogen ions, it is observed that:

- The diffusion of ions causes increase in concentration of ions at the surface.
- Increase in concentration of ions results in decrease in pH at the surface.

The diffusion phenomena of hydrogen ions is analyzed from the Fick's second law. In equation (9), the  $[H^+]_b$  is replaced by twice the concentration of cholesterol as verified from the chemical reactions of cholesterol with the electrode in presence of the enzyme as shown in equation (2).

The results are shown in fig. (3). The plot shows the variation in concentration of hydrogen ions with diffusion from surface to bulk with time. It is seen that diffusion increases with time.

The threshold voltage at different surface potential is found using equation (7). Then, using equations (11) and (12), the drain current is computed at different threshold voltage for the G-ENFET. These current variations can be linked with cholesterol concentration.

The plot in fig. (4), shows a linear dependency of current with concentration of substrate. Such linear dependency was also observed in the experimental results for the fabricated device.

From the physical model, the effect of change in current is observed for change in drain voltage at various substrate concentration. The simulations of the model was done for variation of  $V_{ds}$  from 0 to 0.4 volts and concentration of cholesterol is varied from 5mM to 25mM. The curves obtained saturate after 0.2 volts. The results obtained from modeling are then compared to the experimental results of the fabricated device [3] as shown in fig. (5). The comparison plot shows a good fit between the two results.

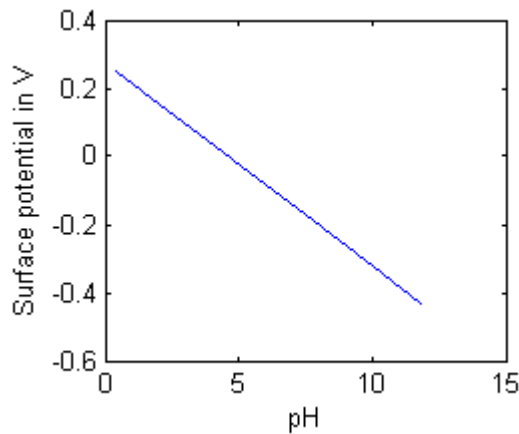

Fig. 2. Surface potential variation with pH

From this figure the calculated sensitivity of the device is about 59.6 mV/pH

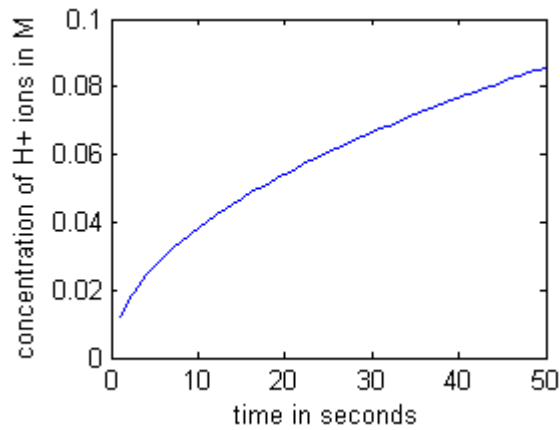

Fig. 3. Diffusion of hydrogen ions from surface to bulk with time

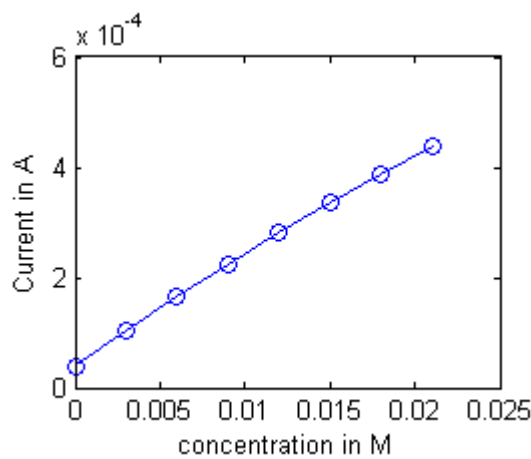

Fig. 4. Drain current with concentration of substrate

The sensitivity from the above graph is calculated to be about 18 micro ampres /mM where as the experimental sensitivity calculated at [3] is about 20 micro ampres/mM

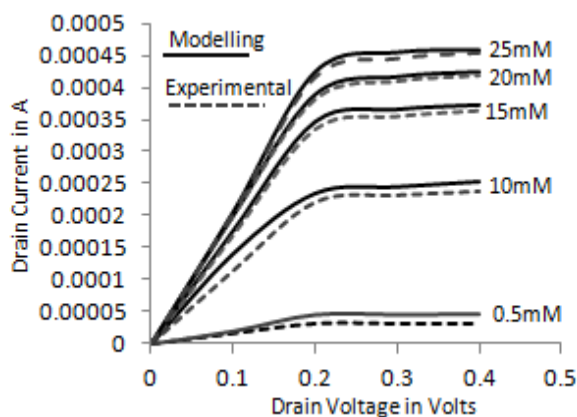

Fig. 5. Drain Current vs Drain voltage for different concentration.

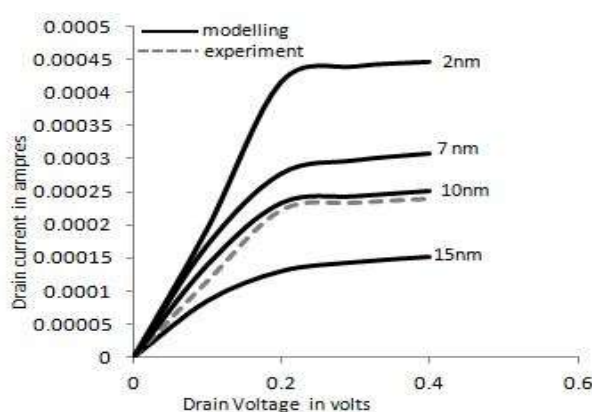

Fig. 6. Drain Current vs Drain voltage for different oxide thickness

The plot between drain current and drain voltage for different oxide thickness at substrate concentration of 10 mM shows that as the oxide thickness increases saturation is reached at smaller values of drain current. This conclusion can follow from the fact that the threshold voltage of the device depends inversely with respect to oxide thickness, hence larger the oxide thickness, smaller is the threshold voltage and hence saturation is reached for small values of current.

#### IV. CONCLUSION

A physical model for G-ENFET was presented in this paper for cholesterol detection. Use of high  $\kappa$  dielectric compatible graphene instead of Si as semiconducting substrate material has paved the path towards device miniaturization. This modified G-ENFET model helps in testing of fabricated devices from theoretical point of view. This model can also be used for other biomolecules (like, glucose, acetylcholine, urea etc.) detection with few modifications.

#### REFERENCES

- [1] T. Vering, W. Schuhmann, H. L. Schmidt, T. Mikolajick, T. Falter, H. Ryssel, J. Janata, "Field-effect transistors as transducers in biosensors for substrates of dehydrogenases," *Electroanalysis*, vol. 6, no. 11-12, pp. 953–956, November-December, 1994.
- [2] A. H. C. Neto, F. Guinea, N. M. R. Peres, K. S. Novoselov, A.K. Geim, "The electronic properties of graphene," *Reviews of Modern Physics*, vol. 81, no. 1, pp. 109–163, January-March, 2009.
- [3] M. A. Barik, M. K. Sarma, C. R. Sarkar, J. C. Dutta, "Highly sensitive potassium-doped polypyrrole/carbon nanotube-based enzyme field effect transistor (ENFET) for cholesterol detection," *Appl. Biochem. Biotechnol.*, vol. 174, no. 3, pp. 1104–1114, October, 2014.
- [4] P. K. Sharma, J. C. Dutta, M. A. Barik, M. K. Sarma, "Numerical modeling of potassium doped polypyrrole/carbon nanotube graphene-based cholesterol enzyme field effect transistor," *Int. J. Numer. Model.*; e2223, vol.

- 30, no. 6, pp. 1-8, November/December, 2017.  
<https://doi.org/10.1002/jnm.2223>
- [5] M. Grattarola, G. Massobrio, Bioelectronics handbook: MOSFETs, biosensors, and neurons, McGraw-Hill., pp 110-116, 1998
- [6] M. Grattarola, G. Massobrio, S. Martinoia, "Modeling H<sup>+</sup>-Sensitive FET's with SPICE", IEEE Transactions on Electron Devices, vol. 39, no. 4, pp. 813–819, April, 1992.
- [7] L. Bousse, N. F. De Rood, P. Bergveld, "Operation of chemically sensitive field-effect sensors as a function of the insulator-electrolyte interface," IEEE Trans. Electron Devices, vol. 30, no. 10, pp. 1263–1270, October, 1983.
- [8] D. E. Yates, S. Levine, T. W. Healy, "Site-binding model of the electrical double layer at the oxide/water interface," J. Chem. Soc. Faraday Trans. 1 Phys. Chem. Condens. Phases, vol. 70, pp. 1807–1818, 1973.