

# Design and Failure Analysis of Rotavator Blade by Means of CAD and FEA Tool

Prajyot Vilasrao Labhsetwar, Rucha Sunil Lonkar, Rohit Sanjay Rajurkar, Sanket Subhash Arsod

*Student, Mechanical Engineering Department, Jawaharlal Darda Institute of Engineering and Technology, Yavatmal, MH, India*

*Student, Mechanical Engineering Department, Jawaharlal Darda Institute of Engineering and Technology, Yavatmal, MH, India*

*Student, Mechanical Engineering Department, Jawaharlal Darda Institute of Engineering and Technology, Yavatmal, MH, India*

*Student, Mechanical Engineering Department, Jawaharlal Darda Institute of Engineering and Technology, Yavatmal, MH, India*

Submitted: 10-05-2022

Revised: 19-05-2022

Accepted: 22-05-2022

## ABSTRACT:

Rotavator is utilized to prepare the soil before plantation. It removes the unwanted soil rocks and makes soil smoother. It consists of core and rotavatorblades mounted on it. There are several types of rotavator blades are available. Some of them are in L shape; some of them are having C shape etc. Depending on nature of soil, type of blade can be selected. But these blades are fails most of the time during high stress working. It may also fail due to the big rocks coming in the core while working.

Rotavator blade is very important and we need to predict its failure before working. In this paper we are trying to optimize the design of rotavator blade by changing the gripping mechanism at the tail respectively. For this purpose, we have selected rotavator blade with 42mm bending radius. Low Carbon Steel material is generally used in India for Rotavator Blade which is considered as a base metal in this project. Structural analysis, Torque Analysis, Buckling and Vibration analysis is to be performed on blade with different gripping mechanism. ANSYS 2020 R1 is used as a FEA tool to perform these analyses. Before that CAD model of rotavator blade is created in CATIA V5R21 software. Based on the all analysis results the conclusion is drawn for this project.

**Keywords:** Rotavator Blade, Gripping Mechanism, ANSYS 2020 R1, FEA Tool.

## I. INTRODUCTION TO ROTAVATOR BLADE

The rotary tillage machine has been used in soil-bed preparation and weed control in the field of fruit gardening agriculture. It has a large capacity for cutting, mixing to topsoil preparing the seedbed directly. It has a more mixing capacity seven times than a plough.

Its components work under miscellaneous forces due to power, vibration, pointless, impact effect of soil parts as after reaching to higher side. The manufacturing and design optimization errors can be minimized by its components design analysis and optimization.

### 1.1 Blade configurations

There are two types of blade configuration used in rotavator. The following blade configuration shows high grade of cultivation,

- Three blade configuration
- Two blade configuration

**1.1.1 Three Blade Configuration:** This is the standard blades configuration and has a three pair of blades per flange except the end flanges which are fitted with one hand only.



**Fig. 1:** Three Blade Rotavator Configuration

**1.1.2 Two Blade Configuration:** The rotor may be converted into two blade configuration. Two blades per flange used in the rotavator except the end flanges. In this blade configuration, less tendency to the rotor to clog in sticky soil conditions. A cloddy finish can be obtained and rotor can be driven at faster rpm.

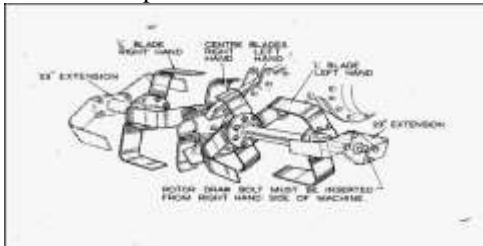

**Fig. 2:** TwoBlade Rotavator Configuration

**1.1.3 'L' blade:** The long shank blade as the name implies, has longer shank than the standard power blade. This allows the greater clearance between the blade and rotor. With this, a greater depth of cultivation is obtainable if tractor power and conditions are allowed.

"L" blades are the original form of rotary blades that were used on the first Rotavator machines of their time. They were designed to fit a constant depth across the full width of tillage. The leading edges of the shank and foot where sharpened for easy penetration and the sole of the blade foot was curved inwards from front to rear so that as the blade cut into the soil; it was pulled forward by the motion of the tractor - only the cutting edge of the blade was in contact with the ground. This curvature of the foot and of the blade was, and still is, an important feature of all Howard blades. With no more than the cutting edge in contact with the soil beneath the blade, not only is there no downward pressure to compact the ground below, but the blade itself is self-sharpening. "L" blades are still the best choice for Shallow cultivations of 2" or less, or in base of the tillage zone needs to be leveled.

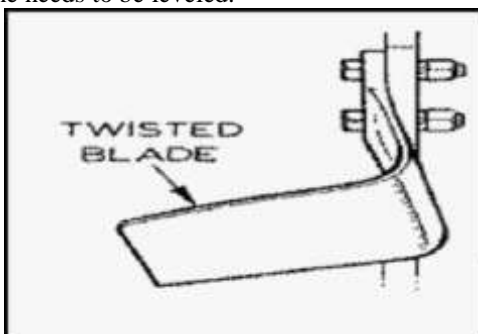

**Fig. 3:** LType of Blade

## II. LITERATURE SURVEY

D.Ramesh Kumar<sup>1</sup> and P.Mohanraj<sup>2</sup>, "Design and Analysis of Rotavator Blades for its Enhanced Performance in Tractors". The design and optimization of rotary tillage tool on the basis of simulation and finite element method is done by using ANSYS software. [1]

Prof. R.V. Kakde<sup>1</sup>, "Review Paper on Analysis of Rotavator Blade". Rotary rotavator or tiller is one of the tilling machines most suitable for seedbed preparation. In a Rotary tillage machine, Blades are the critical parts which are engaged with soil to prepare the land and to mix the fertilizer. [3]Subrata Kr. Mandal<sup>1\*</sup>, Dr. Basudeb Bhattacharyya<sup>2</sup>, "Rotary Tiller's Blade Design using Finite Element Analysis (FEA)". Blades are the main critical parts of a rotary tiller, which are engaged with soil to prepare the land. Their paper aims at design optimization of rotary tiller blades using modern tools like FEA. [4]

G. M. Vegad, Dr. R. Yadav, R. G. Jakasania, "Structural Analysis of Hatchet Type Rotavator Blade in CAD Software". In their study finite element analysis of hatchet type blade of rotavator was carried out using Solidworks and ANSYS software. 3D model of blade was made using Solidworks software and static structural analysis of blade was carried out using ANSYS software. [5]

### 2.1 Literature Summery

By studying all above journal papers, it is found that the CAD Modelling and FEA Method is one of the best suitable method for design and testing of rotavator blade. Research shows the importance of these two tools for design of rotavator blade. Static Structural and dynamic conditions are taken into consideration to analyse the rotavator blade.

- 1) Rotavator blade life is poor due to the higher stress implementation.
- 2) Replacement of blade is more beneficial than the repair.
- 3) There is large scope for the rotavator blade design
- 4) Different materials with different rotavator blade geometries may give the better results.
- 5) Focus needed on the rotavator blade life improvement.

## III. CAD MODELING OF ROTAVATOR BLADES

Figure 4.2 and figure 4.3 shows the rotavator blades prepared in CATIA V5R21 software. Various commands like Pad, Pocket, Shaft etc from part module and coincident, contact,

offset etc from assembly module have used for this purpose. All dimensions are taken from the sample reference. Further this CAD file is converted into STEP file format which is one of the popular neutral file formats. As we have seen that Fig. 4 is a existing blade while Fig. 5 is updated rotavator blade where the gripping mechanism is changed.

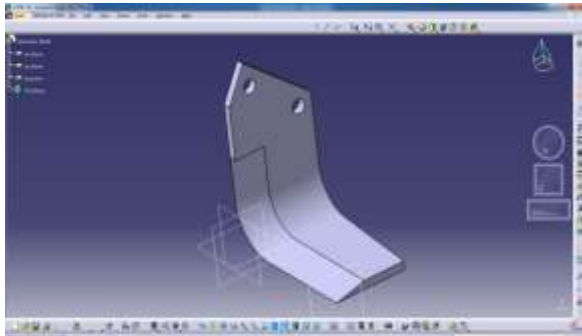

Fig. 4: Rotavator blade with 42 mm radius in CATIA V5R21 Software

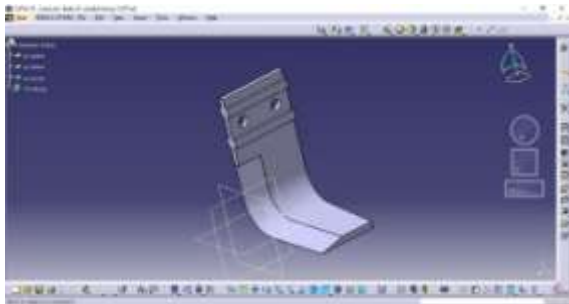

Fig. 5: Updated Rotavator blade with same radius in CATIA V5R21 Software

#### IV. FEA ANALYSIS OF ROTAVATOR BLADE

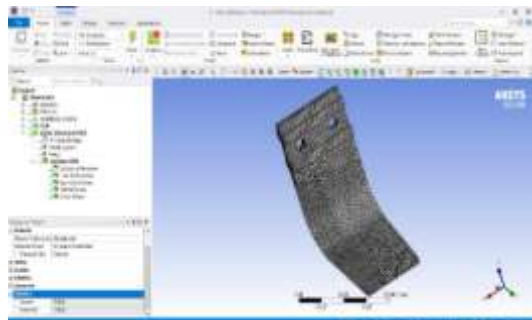

Fig. 6: Meshed view of Existing Rotavator Blade

Table1: Nodes and Elements

Type of Element	3D Tetragonal
No. of Elements	10954
No. of Nodes	20308

#### 4.1 Material Properties Applied

For this study we have selected Low Carbon Steel as a base metal for rotavator blade. To perform structural analysis we need the properties of this metal. Following table is showing the metal and its respective properties.

Table2: Properties of Low Carbon Steel Material.

Property	Value
Young's Modulus (E)	2e5 MPA
Poisson's Ratio ( $\mu$ )	0.275
Density ( $\rho$ )	7870kg/m <sup>3</sup>

#### 4.3 Structural Analysis Results for Modified Rotavator Blade

To simulate the proper physical condition, loads and fixed displacement are to be attached properly. In case of updated rotavator blade, it is fixed at the two slot grips which are attached on the core. For this project rotavator blade used in heavy duty vehicle like tractor is considered. Hence the load which is to be applied on rotavator blade is considered including thrust and torque. Hence the Actual Boundary Conditions are as follows.

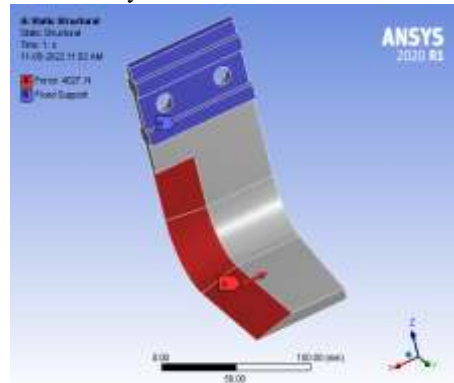
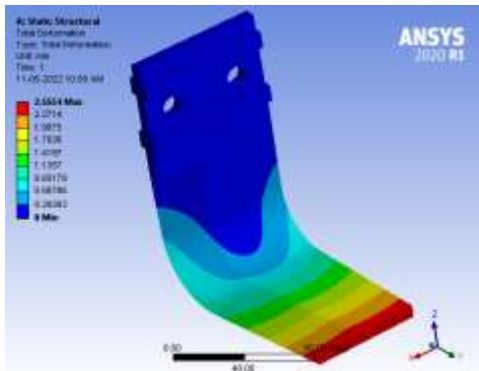

Fig. 7: Boundary Conditions on rotavator blade

By performing Structural Analysis following results are obtained. We have considered 42mm radius blade for analysis with low carbon steel material.



**Fig. 8:** Total Deformation due to loading

Figure 8 shows the total deformation obtained due to application of 4027 N load. Maximum 2.55 mm deformation at the tip of the blade is observed which is less than existing blade. Applied load is considered in a red soil.

By Observing figure 9, the equivalent stresses induced is maximum 382 MPa. The capacity of rotavator blade to sustain the stresses is not more than 400 MPa. Hence the chances of failure are rare as compared to existing blade.

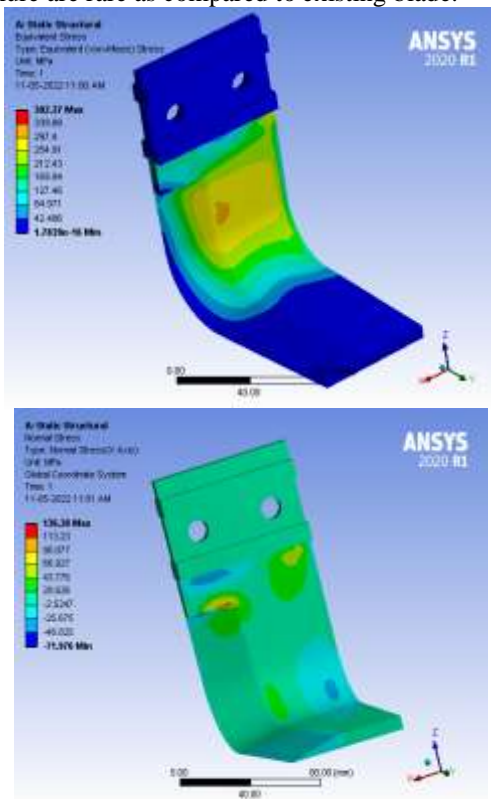

**Fig. 9:** Equivalent stresses **Fig. 10:** Normal stresses due to loading

Figure 10 shows the normal stresses induced. In existing blade these stresses are 433 MPa and in modified blade this stress value is only 136 MPa. Hence Modified blade is more stable than existing blade and no or less chances of failure.

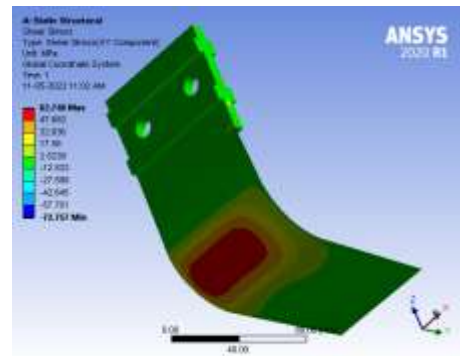

**Fig. 11:** Shearstresses due to loading

Figure 11 shows the shear stresses obtained in the blade and these stresses are very low. Blade is safe from shear stresses.

By observing all the above structural analysis results, we found that the deformation value is much lower than existing blade deformation value. Also, stresses are in safe limit. Hence the chances of failure are very less in modified rotavator blade. These results indicate the lower chances of blade failure in such high loading. And during working of rotavator blade, such loading may occur at any instant. Hence the improvement in results are done.

#### 4.4 Results and Discussion

In order to elaborate results generated we have considered two cases of rotavator blade. First is of existing blade with 42 mm bending radius. Second is of Modified Rotavator blade with 42 mm bending radius. We have improved design to reduce chances of failure.

### V. TABULATED RESULTS OF ALL ANALYSIS

**Table 3:** Static Structural and Torque Analysis Result Comparison

Sr. No.	Type of Blade	Type of Analysis	Total Deformation (mm)	Equivalent Stress (MPa)	Normal Stress (MPa)	Shear Stress (MPa)
1	Existing Blade	Structural	3.08	463.14	433.09	102.52
2		Torque	2.78	603.26	459.87	212.05
3	Modified Blade	Structural	<b>2.55</b>	<b>382.37</b>	<b>136.38</b>	<b>62.74</b>
4		Torque	2.70	620	427.4	205.99

By observing above table 3, we found that the structural analysis results for modified blade is much better than the existing blade. It means that the modified Blade is more stable and has less chances of failure. We got approximately similar results for torque analysis in both types of blades. The value of equivalent stresses are higher in both cases. But in the case of modified blade, these stresses are developed at the tip not on the grip. Hence chances of wear and failure are less in case of modified blade.

Buckling analysis results will state the buckling deformation in both cases which are lesser than the actual deformation due to torque and loading. Hence improvement in metals used for manufacturing of rotavator blade can be suggested.

By observing below table 4 for vibration analysis results for both types of blades, we found that the both blades have maximum frequency range. It means that the both blades are safer in vibrations. But still modified blade has 300 Hz more frequency value than existing blade. Means it is safer than existing blade.

**Table 4:** Comparison of Vibration Analysis

Sr. No.	Type of Blade	Mode	Deformation (mm)	Frequency (Hz)
1	Existing Blade	Mode Shape 1	82.35	180.92
2		Mode Shape 2	88.06	294.22
3		Mode Shape 3	77.6	575.55
4		Mode Shape 4	155.12	1495.7
5		Mode Shape 5	138.51	1919.8
6		Mode Shape 6	106.72	3037.9
7	Modified Blade	Mode Shape 1	81.48	181.44
8		Mode Shape 2	89.03	315.68
9		Mode Shape 3	76.45	567.77
10		Mode Shape 4	165.27	1516.2
11		Mode Shape 5	117.15	1951.1
12		Mode Shape 6	125.37	3359.8

#### Graphs Generated

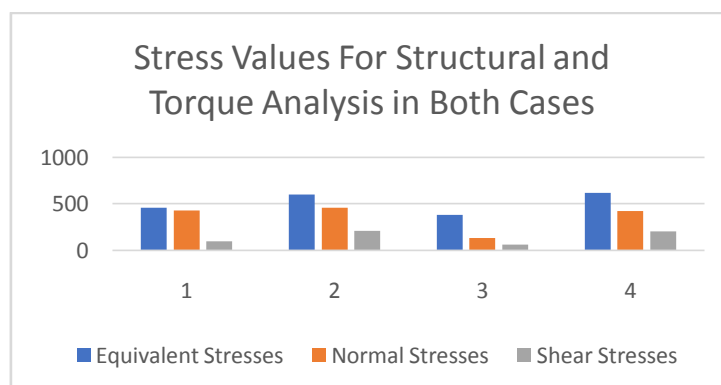

**Fig. 12:** Stress Values obtained in Both Cases

Figure 12 shows the Stress Values obtained in Both Cases. Values for 3<sup>rd</sup> and 4<sup>th</sup> columns which are denoted for Modified Blade are less as compared with existing blade.

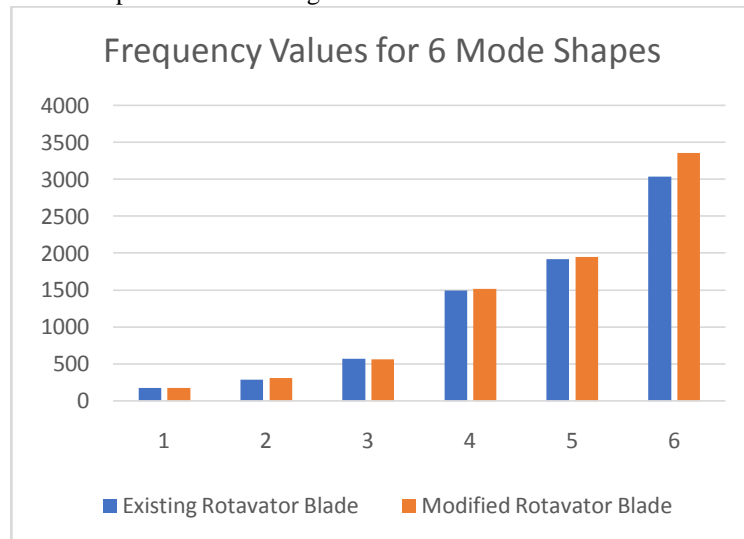

**Fig. 13:** Frequency values for both Types of Blades

By observing figure 13, it is found that the frequency range for each mode in both cases are approximately same. Only Modified blade has better frequency value at 6<sup>th</sup> mode shape.

## VI. CONCLUSION

By observing all the results generated by the analysis in both existing and modified rotavator blade, it is found that Modified blade is more stable, has better Natural Frequency range and able to achieve longer life span even if the blade works at extreme high torque and loading conditions. Hence the modification done in a gripping will improve the blade performance. This type of modification is suggested in order to achieve longer life of blade with same cost.

## REFERENCES

- [1] D.Ramesh Kumar<sup>1</sup> and P.Mohanraj<sup>2</sup>, "Design and Analysis of Rotavator Blades for its Enhanced Performance in Tractors". Asian Journal of Applied Science and Technology (AJAST) Volume 1, Issue 1, Pages 160-185, February 2017
- [2] Prof. R.V. Kakde, "Review Paper on Analysis of Rotavator Blade". Vol-2 Issue-3 2016 IJARIE-ISSN(O)-2395-4396, www.ijarie.com
- [3] Subrata K.R. Mandal, Basudeb Bhattacharyya, Use of Cad Tool for Design and Development of Rotavator Blade". Middle-East Journal of Scientific Research 20 (2): 171-177, 2014, ISSN 1990-9233, © IDOSI Publications, 2014, DOI: 10.5829/idosi.mejsr.2014.20.02.11564
- [4] Subrata Kr. Mandal<sup>1\*</sup>, Dr. Basudeb Bhattacharyya<sup>2</sup>, "Rotary Tiller's Blade Design using Finite Element Analysis (FEA)". International Journal of Modern Studies in Mechanical Engineering (IJMSME) Volume 1, Issue 1, June 2015, PP 19-26 www.arcjournals.org
- [5] G. M. Vegad, Dr. R. Yadav, "Structural Analysis of Hatchet Type Rotavator Blade in CAD Software". National Conference on Recent trends in Engineering, Management, Pharmacy, Architecture and Science, 'NCETEMPAS - 2016'
- [6] Prof. Shinde V.B.1, Mr. Malve R.N.2, "DESIGN AND DEVELOPMENT OF ROTAVATOR BLADE". International Journal of Science, Technology & Management www.ijstm.com, Volume No.04, Issue No. 04, April 2015 ISSN (online): 2394-1537
- [7] Srinivasan. K1, Viswanath R. P2, "Design and Optimisation of Blades for Rotavators". International Journal of Innovative Research in Science, Engineering and Technology, An ISO 3297: 2007 Certified Organization, Volume 4, Special Issue 4, April 2015, National Conference on Trends in Automotive Parts Systems and Applications (TAPSA-2015), On 20th & 21st March
- [8] Gopal U.Shinde<sup>1</sup>, J.M.Potekar<sup>2</sup>, R.V.Shinde<sup>3</sup>, "Design Analysis of Rotary Tillage Tool Components by CAD-tool:

- Rotavator". 2011 International Conference on Environmental and Agriculture Engineering, IPCBEE vol.15(2011) © (2011) IACSIT Press, Singapore
- [9] Rohan Nanabhau Pawar<sup>1</sup>, Dr.S.I.Kolhe<sup>2</sup>, "Design and Analysis of Rotavator Blade for its Enhanced Performance in Tractors". International Research Journal of Engineering and Technology (IRJET) e-ISSN: 2395-0056 Volume: 07 Issue: 07 | July 2020 www.irjet.net p-ISSN: 2395-0072
- [10] Subrata Kr Mandal, Dr. Somenath Mukherjee, "Optimization of Design Parameters for Rotary tiller's Blade". Proceedings of the 1st International and 16th National Conference on Machines and Mechanisms (iNaCoMM2013), IIT Roorkee, India, Dec 18-20 2013
- [11] D.Ramesh Kumar<sup>1</sup> and P.Mohanraj<sup>2</sup>, "Design and Analysis of Rotavator Blades for its Enhanced Performance in Tractors". Asian Journal of Applied Science and Technology (AJAST) Volume 1, Issue 1, Pages 160-185, February 2017
- [12] Jeevarathinam.A, Velmurugan.C, "Design Modification and Analysis of Rotavator Blade". IOSR Journal of Mechanical and Civil Engineering (IOSR-JMCE) e-ISSN: 2278-1684, p-ISSN: 2320-334X PP 43-50 www.iosrjournals.org
- [13] Dr. Ashok G. Matani<sup>1</sup>, Ankush D. Bhishnurkar<sup>2</sup>, "Use of Cad Tool for Design, Analysis and Development of Rotary Tillage Tool". International Journal of Science and Research (IJSR) ISSN (Online): 2319-7064 Index Copernicus Value (2013): 6.14 | Impact Factor (2013): 4.438
- [14] Mr. Prasad D. Tupkari<sup>1</sup>, Dr. P. K. Sharma<sup>2</sup>, "Computer Aided Design and Analysis of Rotavator Blade". International Journal of Advanced Technology in Engineering and Science www.ijates.com, Volume No.02, Issue No. 05, May 2014 ISSN (online): 2348 – 7550
- [15] Mr. Ravindra B. Kankal and Prof. K. R. Sontakke, "Design and Analysis of L Shape Rotavator Blade". IJARST ISSN (Online) 2581-9429, ISSN (Print) 2581-XXXX, International Journal of Advanced Research in Science, Communication and Technology (IJARST), Volume 1, Issue 1, January 2020
- [16] Prof. N.A.Ghanokar<sup>1</sup> & Prof. S. P. Pawar<sup>2</sup>, "Computer Aided Design and Analysis of Rotary Tillage Tool Component for Failure". Global Journal of Engineering Science And Researches, [NC-Rase 18] ISSN 2348 – 8034 DOI: 10.5281/zenodo.1494037 Impact